

Received October 19, 2019, accepted October 29, 2019, date of publication November 4, 2019, date of current version November 14, 2019.

Digital Object Identifier 10.1109/ACCESS.2019.2951029

Modeling, Control, and Simulation of a New Topology of Flywheel Energy Storage Systems in Microgrids

**AWS SALEH^{ID}, ABDALKARIM AWAD^{ID}, (Member, IEEE), AND
WASEL GHANEM^{ID}, (Member, IEEE)**

Faculty of Engineering and Technology, Department of Electrical and Computer Engineering, Birzeit University, Birzeit 00970, Palestine

Corresponding author: Abdalkarim Awad (akarim@birzeit.edu)

This work was supported internally by Birzeit University.

ABSTRACT The fluctuating nature of many renewable energy sources (RES) introduces new challenges in power systems. Flywheel Energy Storage Systems (FESS) in general have a longer life span than normal batteries, very fast response time, and they can provide high power for a short period of time. These characteristics make FESS an excellent option for many applications in future power Microgrids (MGs), in particular with integrated RES. The purpose of this paper is twofold. First, a new topology of FESS in MGs is introduced, where the FESS is connected at the same DC-bus of the fuel cells and the Photovoltaic (PV) inverter instead of connecting it with a separate on-grid inverter. Fuel cells are connected at the bus to help the FESS to operate as Uninterruptible Power Supply (UPS) system for longer periods by using the same power electronics components. Not only this topology is cost-effective, but also it allows higher PV penetration levels due to regulating the power flow by the flywheel and it is also more efficient than the traditional topology due to the shortest path of power flow. Second, a detailed simulation model of MGs with FESS is developed. This simulation model makes it possible to explore different scenarios including connected and isolated status of MGs with high levels of PV penetration. The simulation results demonstrate the ability of FESS to withstand changes in the load, PVs and wind, and the ability to provide electricity even when an interruption from the utility grid occurs. Additionally, the common on-grid inverter has been exploited to compensate the reactive power and hence improve the power factor inside the MG.

INDEX TERMS Flywheel, energy storage, modeling, control, simulation, permanent magnet synchronous motor (PMSM), inverter, microgrids.

I. INTRODUCTION

Solar energy is one of the most important RES. Despite all advantages of solar power plants, they still have some critical issues that reduce their usage as an alternative source of generation for electricity. The first one is solar energy is intermittent. The second challenge is the instability of the intensity of solar radiation at a constant rate. So, in order to maintain the stability of production, it is important to use innovative approaches to store energy at high supply periods, and then to re-use later to maintain the stability. Besides being the most economically viable energy source, the technology of power electronics has also facilitated the process of controlling the renewable energy systems.

The associate editor coordinating the review of this manuscript and approving it for publication was Fabio Massaro^{ID}.

The progress in this area has achieved useful and excellent results in the case of MGs connected inverter with low penetration levels [1]. MGs in general are intended to operate in two different operating conditions; the first one is normal interconnected mode where the MG is connected to the main Medium Voltage (MV) network, either being supplied by it or injecting some amount of power into it. The second one is an emergency mode where the MG operates autonomously, in a similar way to physical islands, when the disconnection from the upstream MV network occurs [2]. In these above two modes of operation, there are more than one energy source like PVs, wind turbines, diesel generators and different storage energy sources like batteries and FESS, etc. FESS is an electric machine that operates either at low or at high frequencies as well as a motor in charging mode and as a generator in the discharging mode. It requires a bidirectional

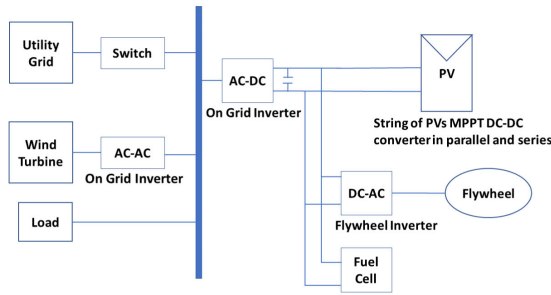

FIGURE 1. System Topology.

converter to convert the variable frequency to a custom fixed frequency and vice versa. This converter runs through two steps: the first step is to convert AC to DC, while the other one is to invert DC to AC, which is similar to the topology of the PV panel's on-grid inverter [3].

FESS is considered a popular energy storage system in the short and medium-term ranging from seconds to minutes, which can be used in isolated wind plants and PV farms [4]. These isolated plants and farms have two scenarios to work; the first one is when the PV panels produce power in high penetration levels in the MG and are regulated by FESS. The Second scenario is when the main supply is disconnected, and FESS and fuel cells work as UPS until diesel generator is ready to cover the load. Therefore, FESS regulates the voltage profile and frequency. In these two scenarios, changing either the solar radiation or wind turbine power or the load will not affect the system performance as the FESS should be able to manage these scenarios.

This paper aims to investigate the performance of the FESS in a completely isolated hybrid coupled MG. The performance will be evaluated regarding metrics such as voltage profile and frequency. Different scenarios will be studied like the effect of changing solar radiation and/ or load on the performance of the MG. Moreover, it is proposed to use the same DC bus of PV panels as shown in Figure 1 to reduce the overall costs of the system as well as to increase the stability of the power quality issues and the reliability in the MGs. The advantages of using this topology can be summarized as:

- It would be possible to deploy higher levels of PV penetration to maintain a stable voltage profile. For instance, the flywheel can be used to absorb part of the power produced by the PV when the PV production is high or injecting some power when the production is low.
- The proposed topology is cost-effective as there is no need to have a separate on-grid inverter for the FESS.
- In our proposed topology the FESS is charged directly at the same DC-bus from the PV panels, so it has higher efficiency than the traditional topology.
- The proposed topology makes it possible to exploit the PV on-grid inverter to solve some power quality issues even when the sun is not shining, e.g. during the night. For instance, the on-grid inverter can be used for reactive power compensation.

II. RELATED WORK

The work in [5] has presented a comparison of MG configurations, including the single AC network, the single DC network, the hybrid AC-DC network, and the 3-NET. The comparison is concerned with the economic operation, power losses, and the interruption costs in a deregulated market model. The results showed that the single AC network is comparably predominant over others.

According to [6], the configurations of Hybrid MG can be divided into two main categories: coupled and decoupled AC MG. The main features of the coupled MGs is the fact that the system is directly connected to the power grid by a transformer. The developing of this network is less expensive than the decoupled one because the AC-DC converter is smaller than the converter in decoupled one. In all these configurations, the energy storage systems have been connected to a separate inverter.

In [7], the authors explored the optimization methods to manage the energy in the power grid by using FESS, since the next generation of power systems should have high penetration levels of RES. They proposed a smart system based on moving average to control FESS to solve the fluctuating issues in RES. The smartness in this algorithm is controlling the charging and discharging periods taking into consideration the production forecast. The authors on this work focused on the abstract level and did not consider the low power electronics level.

The authors in [8] used the FESS to increase the penetration levels of renewable energy systems. They used it in an isolated grid, which has a diesel generator and wind turbine. They measured the effects of adding the FESS for a whole year, it is noticed that FESS decreases the limitation of penetration in the system. They showed clearly that fuel usage is decreased, the system stability is increased, and the power quality is improved.

In [9], the study presented a MATLAB Simulink Model for asynchronous machine FESS for an isolated grid, which consists of a wind turbine generator, a synchronous machine and a consumer load. The results represented the active power, system frequency, FESS-ASM speed, voltages and currents, and direct and quadrature currents. All results showed that the FESS has effectively smoothed the renewable energy power and the variation of consumer load.

In [4], a simple flywheel coupled to an asynchronous generator and spanned at low speed for a medium and short-term energy storage system is proposed. They obtained a constant speed with only 5% variation, where a clutch is used as the connector between the diesel generator and the flywheel. For maximum energy capture from PV panels, the authors in [8] and [3] used flywheel in case of stand-alone systems. In [8], they studied the case with FESS and a battery-energy storage system, where the system is an isolated hybrid system with high penetration levels of PV panels. The results of simulation over a one-year period proved the positive effects of adding FESS and any other storage system.

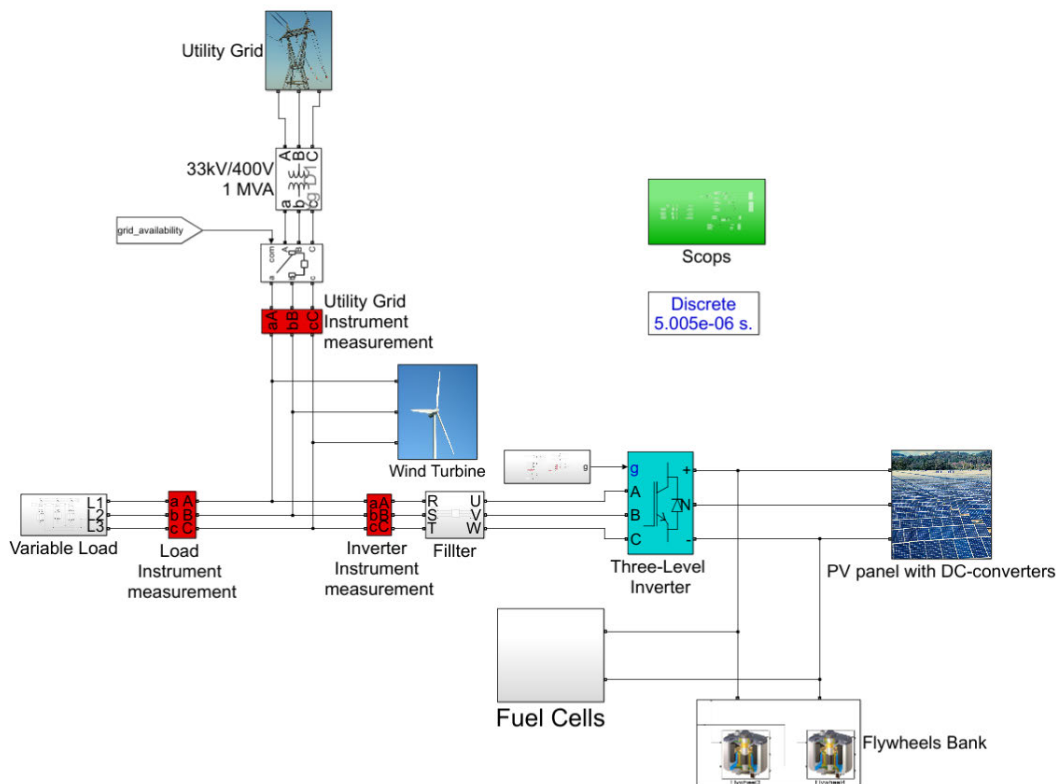

FIGURE 2. A Simulink screenshot of the MG.

The authors in [10], [11] developed a model control of FESS. The FESS should spin from 1000 rpm up to 4000 rpm. It has a power electronic circuit control, bi-directional inverter managing the power flow. The results were the FESS was capable of regulating the DC bus voltage continuously. The voltage sag appeared less than three cycles until the flywheel started to discharge the energy. This fast response proved that the FESS is suitable for UPS applications and voltage profile correction. But due to the low-speed of the FESS, the energy density and efficiency is low.

In [10] a model for Interior Permanent Magnet Synchronous Motor (IPMSM) using MATLAB Simulink was developed. They proposed a low-speed, and a low cost and complexity flywheel, that consists of high tense steel and mechanical bearings. Their main contribution was proposing a low cost lifelong UPS and a method to regulate the power quality parameters using FESS. The authors in [3] discussed the FESS and they suggested using it in various structures and applications in power systems like a UPS system to supply a critical load, where the flywheel was connected with a separate inverter.

A novel design to combine between FESS and supercapacitors was proposed in [12], where the authors considered DC MG. Such topology improved the dynamic performance of the FESS with minimal effects of its size and weight. They have used a field-oriented control for the PM, where the angular reference speed should change with the changes in the error value in the DC bus. In the model, the priority of energy exchange was given to the supercapacitors.

The authors in [13] investigated the advantages of integrating the hybrid-energy storage system (HESS) in a residential MG with a PV plant, battery, and FESS. The effect of flywheel on the battery life was estimated, resulting in significant improvement with respect to non- hybrid configurations. From the energy point of view, they proved that the hybrid- energy storage system has allowed an increase in the self-consumption with respect to the PV production with a contextual decrease in the total amount of purchased electricity. Moreover, they showed that the flywheel introduction largely contributed to the improvement of battery duration. Preliminary estimations showed that the HESS battery duration almost tripled for lead-gel packs and even more for ion-lithium ones. The focus of this work was not on the power electronics level, but just on the energy management approaches.

It can be concluded from the previous works considered so far, the flywheel was considered as a separate part of the MG and it was connected on a separate inverter. In our work, we propose connecting it on the same DC bus of the PV panels and the fuel cell to improve the operation of the MG in both connected and isolated modes.

III. SYSTEM MODELING

In this section, a simulation model is presented to explore different FESS usage scenarios. A Simulink screenshot of the system is shown in Figure 2. The simulation model can translate the high-level energy management commands into



FIGURE 3. PV Topology.

power electronic level. The system contains the following main components:

- PV panels
- Wind turbine
- Fuel cells
- Inverters
- Flywheel System
- Load
- Bypass Switch

A. PV PANELS

MATLAB-based model of a PV module can be used to simulate PV systems such that we can study the effect of radiation on the available power.

The system includes 1 MW PV panel system consists of 4 parallel strings of DC converters; each string contains 16 modules of the converter as shown in Figure 3.

TABLE 1. Specifications of PV modules suntech power STP320-24-Ve used in the simulation.

| Component | Value |
|--------------------------------|--------|
| Maximum Power | 320 W |
| Open circuit voltage | 45.6 V |
| Voltage at maximum power point | 36.7 V |
| Short-circuit current | 9.07 A |
| Current at maximum power point | 8.72 A |
| Cells per module | 72 |

TABLE 2. Specifications of the DC-DC boost converters for PV panels.

| Component | Value |
|------------------------------|--|
| Capacitor | 20 μF in the output terminal, 100 μF total capacitance |
| Transistor | IGBT type |
| Coil inductance | 5mH |
| The rating of input voltage | 73.4 V |
| The rating of output voltage | 110 V |

This topology mitigates the impact of partial shading. Each converter consists of 25 parallel strings and each string contains 2 modules. The specification of PV modules used in the simulation is shown in Table 1.

The interface device between the PV panels and the DC bus is a DC-to-DC boost converter. It extracts the maximum power point of PV panel power using a controller that is based on the Perturb and Observe algorithm [14]. The specification of DC-DC boost converters used in the simulation is shown in Table 2.

B. ON GRID INVERTER

On-grid inverter produces a synchronized voltage with the network like synchronous generator [15]. It injects controlled amounts of real power and reactive power to the network. The system contains a controller with several internal loops. In this paper, a new method of controlling the real and reactive power is proposed which exploits the existence of Flywheel energy system. This approach enables us to manage bidirectional flow of active and reactive power. i.e. from the grid to FESS and the other way around. The FESS is coupled with PV system and a fuel cell. Moreover, this inverter provides the power continuously even if an interruption in the utility grid happen. This is done by disconnecting the bypass switch and changing the mode to UPS mode for the same inverter and considering power quality issues using closed-loop control. The reference voltage of the inverter must be synchronized with the measured voltage in the grid at normal mode. But in the UPS mode, the inverter controls the voltage and frequency. The controller transfers the voltage from three phase system to d-q system. The RMS value of phase voltage is given by [16]:

$$V_{\theta-RMS} = \frac{V_{peek-peek}}{\sqrt{2}} \tag{1}$$

The line voltage is given by:

$$V_L = \frac{V_\theta}{\sqrt{3}} \tag{2}$$

The per unit voltage is given by:

$$V_{pu} = \frac{V_L}{400} \tag{3}$$

The vector of V_d , V_q and V_0 is equal to:

$$\begin{bmatrix} \cos(\omega t) & \cos(\omega t - \frac{2\pi}{3}) & \cos(\omega t + \frac{2\pi}{3}) \\ -\sin(\omega t) & -\sin(\omega t - \frac{2\pi}{3}) & -\sin(\omega t + \frac{2\pi}{3}) \\ \frac{1}{2} & \frac{1}{2} & \frac{1}{2} \end{bmatrix} \begin{bmatrix} V_a \\ V_b \\ V_c \end{bmatrix} \tag{4}$$

At on-grid mode (synchronized mode), the inverter regulates the power flow using the controller. The power flow depends on the current flow from the inverter and the angel between the inverter current and the voltage in the grid. Changing the modulation index of the inverter will change the inverter current. So, the controller controls the reference values of the current. To simplify the controller topology, the three-phase system is transferred to d-q system as explained previously. The benefit of using d-q system is that from Equation 6: $V_{d-inverter}$ reference, which generates $I_{d-inverter}$, can be used to control the real power. And from Equation 8: $V_{q-inverter}$ reference, which generates $I_{q-inverter}$, can be used to control the reactive power. The magnitude of V_d and V_q is controlled by the close loop control of real and reactive power. The power injected from the inverter is given by:

$$P = V_{d-grid} * I_{d-inverter} + V_{q-grid} * I_{q-inverter} \tag{5}$$

But $V_{q-grid} = 0$;

$$\text{So, } P = V_{d-grid} * I_{d-inverter} \tag{6}$$

$$\text{And } Q = V_{d-grid} * I_{q-inverter} - V_{q-grid} * I_{d-inverter} \tag{7}$$

But $V_{q-grid} = 0$;

$$\text{So, } Q = V_{d-grid} * I_{q-inverter} \tag{8}$$

The controller is designed such that it can change to UPS mode very fast when it is needed, e.g., when there is an interruption or disconnection from the main grid. The controller measures the difference between the load and inverter power and then it generates the d-q values of the voltage. The controller estimates the new reference values of direct current I_d and quadrature current I_q when an interruption happens at any moment. A screenshot of d-q vectors is shown in Figure 4.

The modulation index of the inverter changes by I_d & I_q as well as by the changes in the DC bus voltage. The controller changes the reference value and mode by using a switch. So, the gate driver signals of the inverter are generated as shown in Figure 5.

The specifications of the three-level inverter used in the simulation are shown in Table 3.

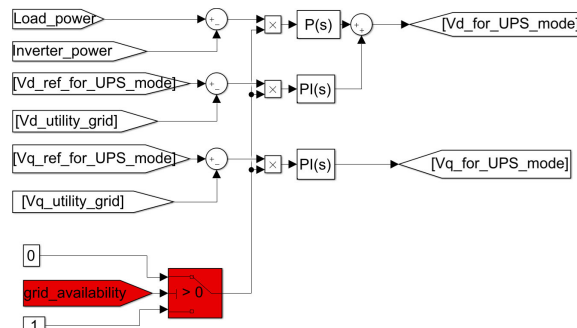

FIGURE 4. d-q vectors generated from the controller for UPS mode.

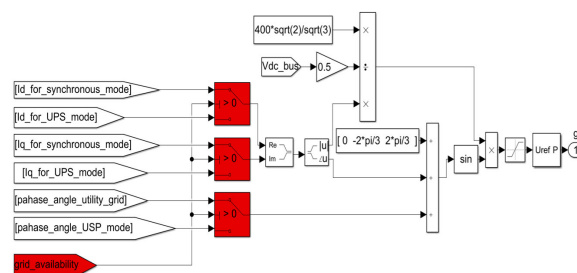

FIGURE 5. Control diagram of the inverter.

TABLE 3. Specifications of the three-level inverter.

| Component | Value |
|--------------------|--|
| Capacitor | 4 mF each one, 8 mF total capacitance |
| IGBT resistance | 1mΩ |
| Snubber resistance | 1MΩ |
| Diode resistance | 0.1mΩ |

C. FLYWHEEL ENERGY STORAGE SYSTEM

The system consists mainly of an inner current-loop and an outer speed-loop [17]. The FESS has two main parts: inverters with space vector control components and a fly-wheel machine. Three-level inverters are used in this work. The flywheel is a permanent magnet synchronous machine. The flywheel and its drivers are shown in Figure 6. The energy stored in the flywheel can be obtained using Equation 9

$$E = \frac{1}{2} J \omega^2 \tag{9}$$

where J is the wheel inertia and ω is the angular speed. The dq model of PMSM can be represented as follows [18]:

$$v_q = R_s i_q + \frac{d}{dt} \lambda_q - \omega_e \lambda_d \tag{10}$$

$$v_d = R_s i_d + \frac{d}{dt} \lambda_d - \omega_e \lambda_q \tag{11}$$

where variables v_d and v_q are dq stator voltage components, i_q and i_d are dq stator current components. ω_e is the angular velocity of the electrical magnet field in the rotor. R_s is the

TABLE 4. Specifications of the FESS.

| Component | Value |
|-----------------------------------|--|
| Capacitor bank | 4 mF each one, 8 mF total capacitance |
| IGBT resistance | 0.2mΩ |
| Snubber resistance | 1MΩ |
| Stator phase resistance of PMSM | 15mΩ |
| Inductances Ld, Lq of PMSM | 314.62μH |
| Flux linkage of PMSM | 167.6348 kV.s |
| Inertia | 50kg.m ² |
| viscous damping & static friction | zero |
| pole pairs | 2 |
| Back EMF waveform | Sinusoidal |
| Rotor type | Salient pole |

Flywheel unit is the machine and its inverter, so the flywheel bank is a group of flywheel units connected in parallel in the same DC bus.

The following points summarize the FESS control:

- The DC bus has a capacitor which is connected to the flywheel inverter and PV converter.
- Grid inverter manages the power flow from the DC bus to the Grid and vice versa.
- Any change in the net of power flow (PV power, fuel cell, Inverter power and Flywheel power) leads to changes in the voltage on the DC bus. For example, if PV power increase suddenly the net of power flow will be positive, then the DC bus voltage will increase.
- Flywheel inverter regulates the DC bus voltage to a reference voltage, so any small difference between the voltage bus and the reference voltage can be eliminated by changing the Flywheel power flow.
- Changes in DC voltage lead to changes in the reference speed of the flywheel.

The specifications of the FESS used in the simulation are shown in Table 4.

D. LOAD

It consists of active and reactive loads in addition to transmission lines. We can control the value of the load during the simulation by connecting/disconnecting parts of the load by using signal builder to control the circuit breaker for each part of the load.

E. MAIN UTILITY CONNECTION

The utility grid is a large power source 33 kV and has a very large load. There is an interface between the utility grid and the micro-grid which is a bypass or fast switch (TRAIC). This switch is used to connect or disconnect from the main grid. The switch can be used to disconnect from the main grid when a problem occurs, e.g., when sag or swell occurs beyond the accepted limits or when an interruption occurs [20].

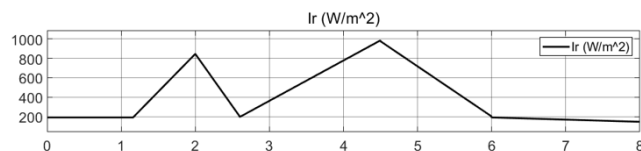

FIGURE 7. Irradiation pattern of PVs.

F. WIND TURBINE

Wind energy is the most known source of RES after solar energy. The model in this paper uses a traditional synchronous machine turbine with on-grid inverter from MATLAB library. The maximum power is 1 MVA. The variation of the power generation at the starting or transient period has a very bad impact on power quality inside the network.

G. FUEL CELLS

The distributed nature of renewable power is the main reason of rising fuel cells. It is one of the promising innovative technologies. Solid oxide fuel cell converts fuel into electricity through a chemical process that is much more efficient than conventional combustion. This resulting in much lower emissions. Fuel cells can produce massive amounts of on-site power at low cost [21].

In this paper we have used the fuel cell model from MATLAB SIMULINK library. We modified only the number of cells to obtain the required voltage and power.

IV. SIMULATION RESULTS

A set of simulation experiments have been performed in this section to show typical FESS applications in MG. In the first four scenarios, we investigated MG consists of FESS, PV, and Load. In the last scenario we explored a MG with wind turbine and fuel cell in addition to the previous components. We build the system such that it is possible to explore scenarios when the MG is connected or disconnected from the main grid. Several metrics such as voltage profile, frequency, and power factor have been studied during this section. We defined a set of scenarios as follows:

- Scenario 1: MG with variable load and fluctuating solar irradiation.
- Scenario 2: Charging FESS from the Utility Grid and PVs.
- Scenario 3: PV and FESS cover the load.
- Scenario 4: FESS as UPS.
- Scenario 5: FESS as UPS with wind turbine and fuel cell.

During the simulation experiments, we used the solar radiation that is shown in Figure 7 and the wind speed is 10 m/s.

Table 5 summarizes the rated values of the different MG components.

A. SCENARIO 1: FLUCTUATING SOLAR IRRADIATION AND VARIABLE LOAD

This scenario aims to show that the system can withstand the variation not only in the solar irradiation but also any changes

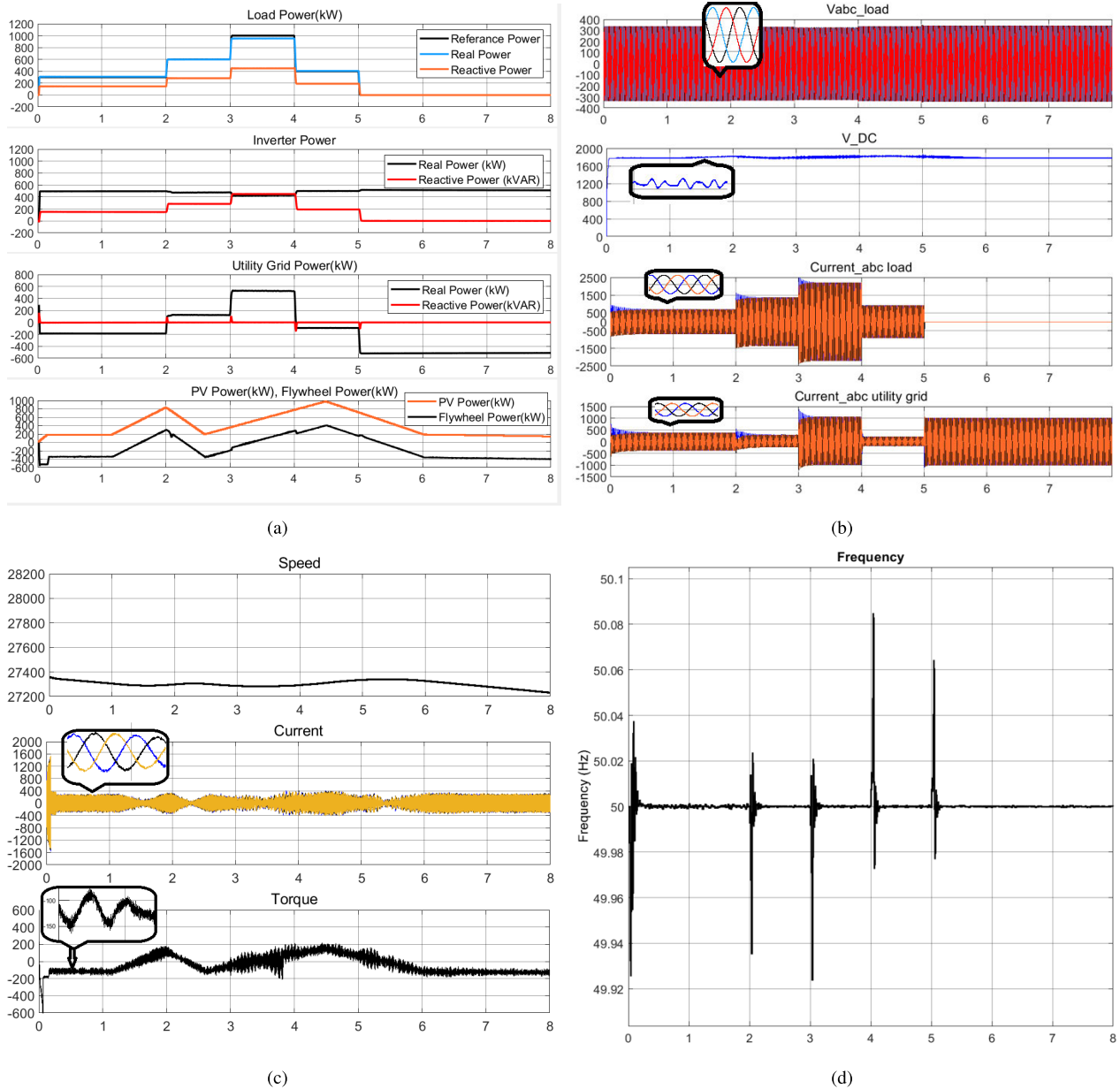

FIGURE 8. Scenario 1: (a) Power flow in the system. (b) Load voltage and current. (c) Flywheel speed, currents and torque. (d) Frequency.

TABLE 5. Summary of the rated power of the different components.

| | |
|--------------|----------------------------|
| PV | 1 MW |
| Wind Turbine | 1 MVA |
| FESS | 1 MVA |
| Fuel Cell | 500 kW |
| Load | from 0 to 1 MW with pf=0.9 |

in the load. Therefore, in this case, the inverter of the system works like synchronous generator with constant power rate with the regulation of the power factor.

In PVs, the changing in radiation affects the voltage of DC-bus. The inverter extracts the maximum power by changing the modulation index and DC reference voltage.

This can have a negative impact on the network performance. For instance, it has a bad impact on the voltage profile. FESS represents a good opportunity to solve these problems because it has a very fast response time to any change in the grid. The load has a 0.9 power factor. Figure 8 depicts the results of the first scenario. The load power in Figure 8(a) provides the reference power (black), the load active power (blue) and the reactive power (red). As can be seen, the load starts with 300 kW then increases to 600 kW at 2 sec and then increases again to 1000 kW at 3 sec then decreases to 400 kW at 4 sec and then goes to zero at 5 sec. All these steps occur in 6 seconds with a very high variation in solar radiation. Finally, the simulation ends at 8 sec. As can be identified from the inverter power (black line)

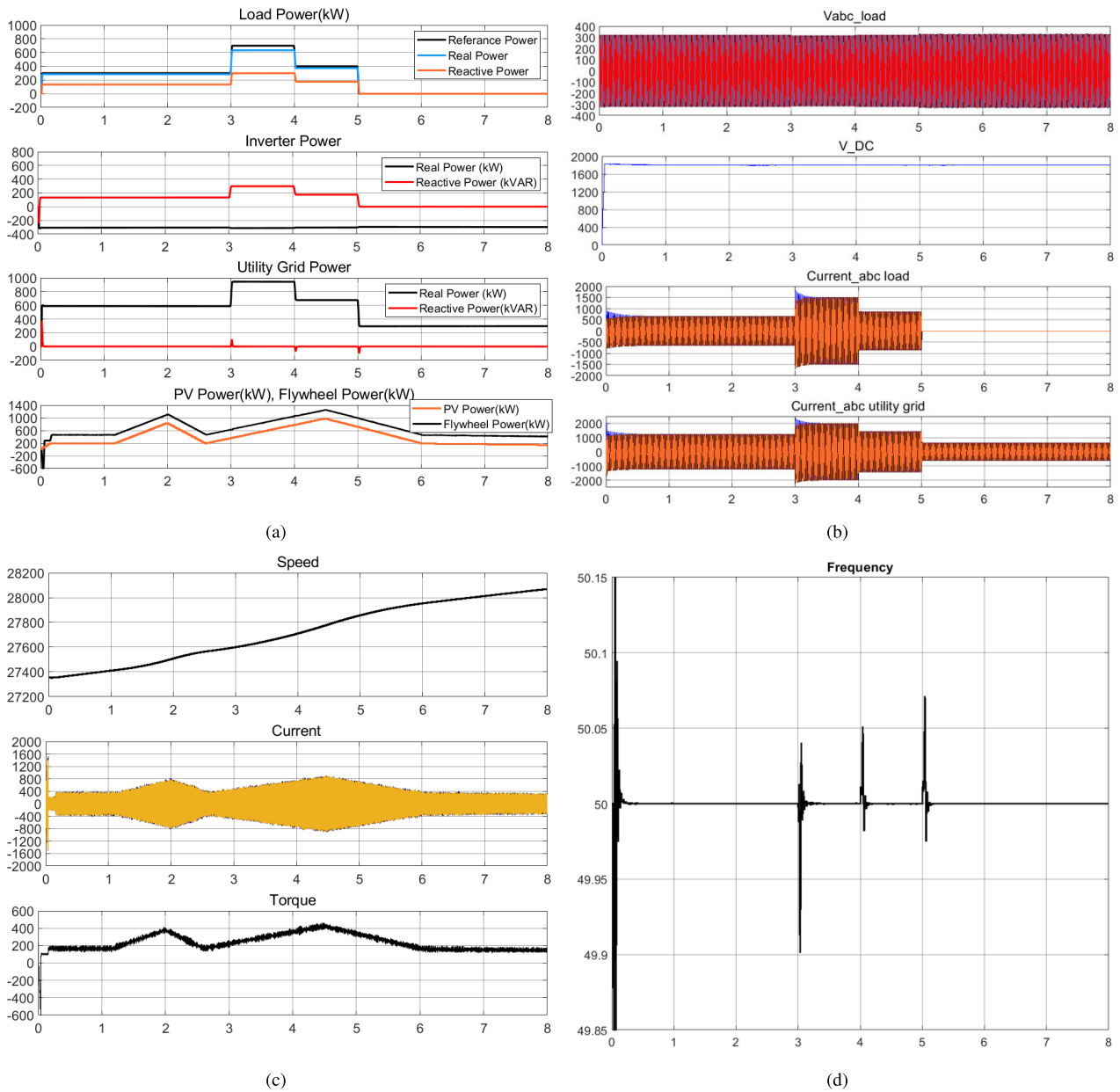

FIGURE 9. Scenario 2: (a) Power flow in the system. (b) Load voltage and current. (c) Flywheel speed, currents and torque. (d) Frequency.

in Figure 8(a), the inverter provides the network with continuous and constant power to the load during the simulation. At the beginning, the PV produces 200 kW and FESS discharges 300 kW. Part of this Power is consumed by the load (300 kW) and the remaining are exported to the main grid (200 kW) which can be seen from the negative value of the utility grid power (black line). When the load starts to increase, the difference between the demand and inverter power is imported from the utility grid. Afterward, when the load becomes zero, the generated power from the inverter (PV and FESS) is exported to the utility grid. It is important to notice that, the inverter was able to compensate the demand reactive power (inverter power, red line) and hence there is

no reactive power imported from the utility grid (utility grid power, red line).

As indicated in Figure 8(b), the voltage profile is stable, DC voltage is constant, and the current changes directly with the changes in load. The zoomed figures provide insight into the exact shape of the different signals. The increase and decrease in FESS speed in Figure 8(c) indicate the charging and discharging of the FESS. The Torque shows how the mechanical power changes in the flywheel due to changes in the electrical power. Figure 8(d) depicts the system frequency. As can be seen, the frequency remains almost constant. The increase and decrease in the frequency are due to a sudden decrease and increase in the load. The response

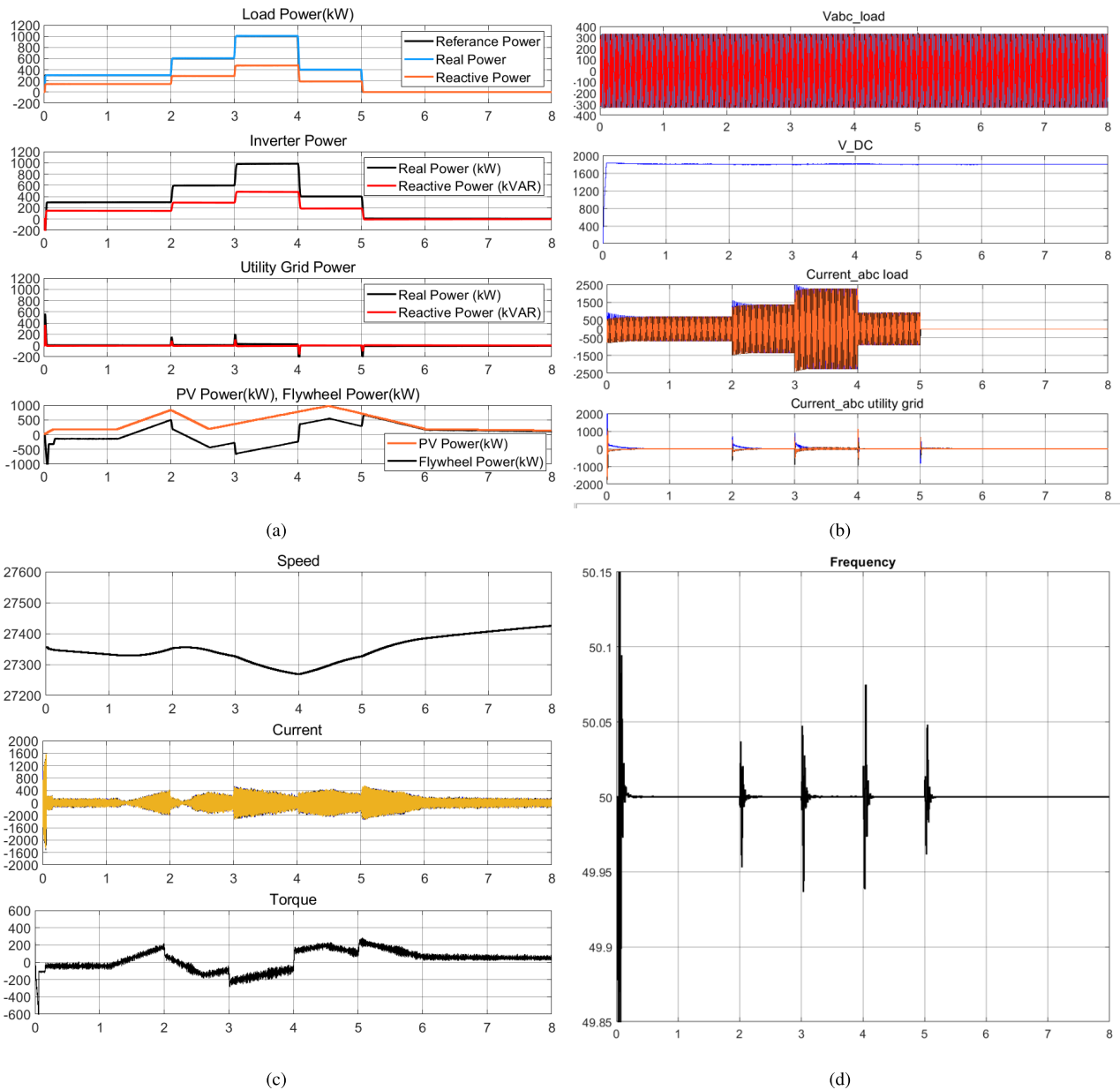

FIGURE 10. Scenario 3: (a) Power flow in the system. (b) Load voltage and current. (c) Flywheel speed, currents and torque. (d) Frequency.

time of the system was very short and was able to maintain almost constant frequency. These figures are generated for all scenarios.

B. SCENARIO 2: CHARGING FESS FROM THE UTILITY GRID AND PVS

In the previous scenario, the FESS was charged from the PV system. In this scenario, the inverter of the system works like a synchronous motor with constant power rate with regulation of the power factor. The FESS will be charged from the utility grid as well as from PVs. The proposed system can control the DC bus reference voltage such that it is able to charge the flywheel from the external grid as can be observed

in Figure 9(a). At the beginning, the on-grid inverter imports a 600 kW from the utility grid and the PV is producing 200 kW. The Load needs 300 kW. The FESS charging power is 300 kW plus the PV's power. Figure 9(b) depicts the system voltage and current when the FESS charges from the MG with fluctuations in PV power and step changes in power load. Flywheel speed, reference speed, currents, and torque of the FESS when charging from the MG and from PVs are shown in Figure 9(c). The frequency of the system is illustrated in Figure 9(d). There are some transient periods due to step changes in the load. When the load increases steeply, the frequency decreases for a very short time and then returns to steady-state, and vice versa.

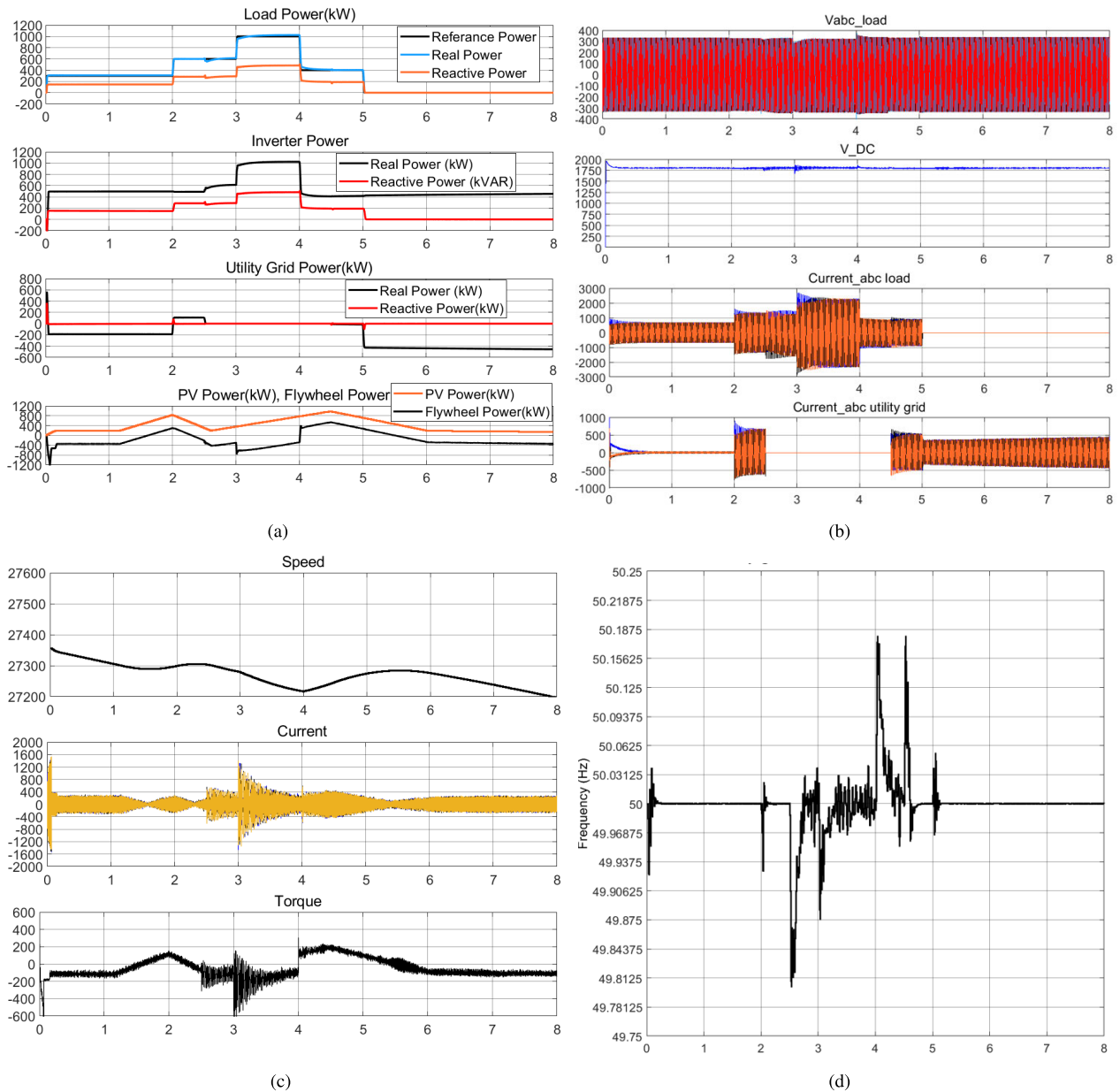

FIGURE 11. Scenario 4: (a) Power flow in the system. (b) Load voltage and current. (c) Flywheel speed, currents and torque at constant power flow to the network. (d) Frequency.

C. SCENARIO 3: THE PV AND FESS COVER THE LOAD

In this scenario, the system measures the load demand to force the inverter to be able to cover this load, as can be identified from Figure 10(a). It's clear that the amount of power produced by inverter from the FESS and PV panels is equal to the load power and hence, the power comes from the utility grid is zero. The inverter was capable to regulate the power flow despite the variations in the radiation and load demand.

As expected, the current flows from the utility grid is around zero as can be seen in Figure 10(b). The importance of the utility grid in this case is to have synchronism between the

inverter and utility grid to be ready for any change in power flow. Figure 10(b) also shows the voltage profile, the total current from the inverter, and the current from the utility grid. The voltage profiles is stable and the current comes from the utility grid is around zero. The small spikes from the utility grid are due to the step changes in the Load.

The speed, torque, and current of the flywheel are changing according to the availability of the power from the PV as can be observed from Figure 10(c). Changing in reference I_q leads to changing is the flywheel speed directly. This means changing in power flow with very fast response. Figure 10(d) depicts the impact of the changes in the system on the

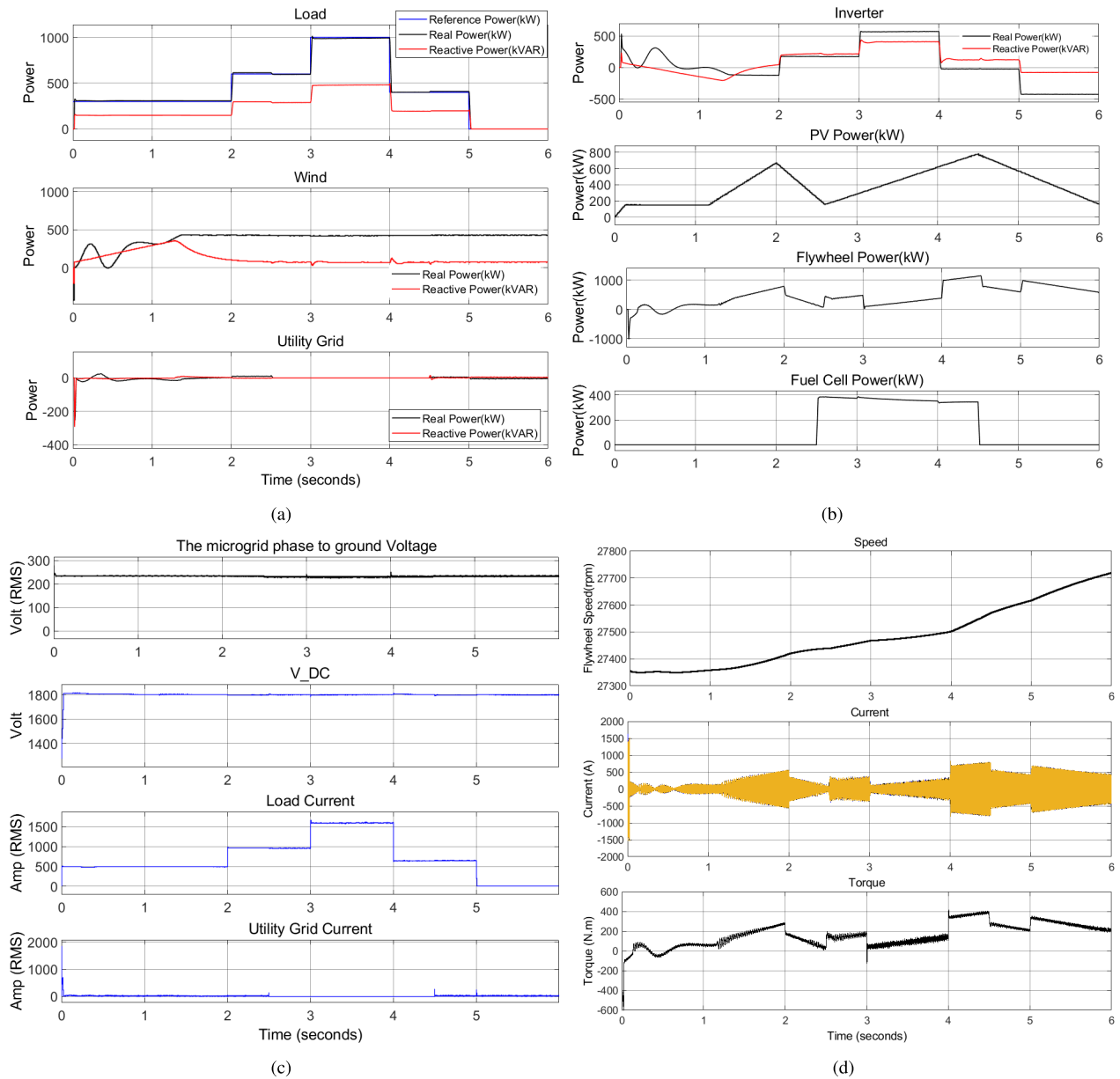

FIGURE 12. Scenario 5: (a) Power Flow in FESS. (b) Power Flow the MG at UPS mode with variable radiation with compensate the power factor. (c) The Load RMS voltage, Load RMS current, Utility grid RMS current and DC bus voltage. (d) Flywheel speed, currents and torque at constant power flow to the network.

system frequency. When the load increases, the frequency goes down slightly and then increases before returning to the normal steady-state value.

D. SCENARIO 4: FESS AS UPS

In this scenario, we explore the behavior of the FESS when there is an interruption from the utility grid. When the utility grid is disconnected, the inverter works as an off-grid inverter. Then, when the power of utility grid returns, the bypass switch connects the MG with the utility grid, but after synchronizing them. After connecting the utility grid with the system, FESS inverter extracts a suitable amount

of energy such that the power quality in the grid remains at steady-state rate of power flow. To explore the behavior of the proposed system in UPS mode, the simulation takes the worst scenario. Similar to the previous scenarios, we have four-step changes in the load, very fast changes in solar power and an interruption happens in the utility grid, then returns after 2 seconds. All these changes occur in the system component within eight seconds. Regulating the solar power by flywheel is explained in the previous section. FESS was a secondary source of power: it imports/exports power from/to the utility grid with a constant rate or variable rate as needed. In the UPS mode, the system works similarly but with very fast response.

If step changes in load happen suddenly, the inverter feeds the load side by side with the utility grid.

The step-change in inverter power should be done when an interruption happens. At this case, the inverter is the sole power source. It's clear that the summation in power flow in the MG is zero.

Figure 11(a) and figure 11(a) illustrates the behavior of the different components of the system when an interruption occurs. At time = 2.5 sec, a disconnection from the utility grid occurs and lasts for 2 sec, the inverter regulates the output voltage easily because the input DC voltage is controlled, i.e., the output current regulated by changing the modulation index. Initially, the load was covered from the inverter and as the load increases at sec 2, the utility grid covers the shortage. However, at time = 2.5 sec, the disconnection from the utility grid forces the inverter to cover the whole load and so, the power comes from the utility grid becomes zero. The inverter was able to cover the variable load. At 4.5 seconds the utility grid returns back, so the inverter returns to inject power synchronized with the grid. In this scenario the inverter returns to inject the power with the same rate as before interruption happened. Notice that when the utility grid is online, the inverter can extract the power as needed. From the second 5 to 8, the load becomes zero and therefore the inverter starts to export power through the transformer to the utility grid. This makes it possible to have a MG that works in the connected and isolated modes.

In this scenario the inverter of the system have produced a 500 kW constant power while the interruption happened. Figure 11(a) shows how the inverter changes the mode softly, it's clear changing the voltage profile remains in a good range. Figure 11(d) shows the frequency of the system. There are changes in the frequency due to the changes in the load, i.e., increasing the load leads to decreasing in frequency and vice versa. Flywheels regulate the voltage in the DC bus and they provide the power fast. Figure 11(c) shows the speed, current, and Torque of the Flywheel in the UPS mode.

E. SCENARIO 5: UPS MODE WITH WIND TURBINE AND FUEL CELLS

In this scenario, the MG includes a wind turbine and a fuel cell. Figure 12(a) shows the wind turbine power. Initially, there was a transit period and then the output power of the wind generator remains almost constant. It is important to notice that the flywheel system was able to hold out against the transient period of the wind and was able to provide the required power. During this scenario the power comes from the utility grid is zero. The fuel cell presents a dispatchable renewable energy source and can be used as a standby generator. Figure 12(b) shows how the inverter power was adapted to withstand the changes in the load, PV, fuel cell and wind power such that it provides the required power to maintain constant voltage profile as can be seen in Figure 12(c). In spite of all changes in the PV, load and fuel cell, the system was able to maintain a constant DC voltage to provide a constant AC voltage for the load.

Figure 12(d) shows the speed, current, and Torque of the Flywheel. The speed was always increasing because; the wind turbine, PV and fuel cell was injecting power into the MG. The increase in the speed was higher after $t = 4$ sec because the load was reduced at this point. The current and torque reflect the load consumption.

V. CONCLUSION

In this paper, we presented a detailed model for FESS and explored different scenarios using MATLAB Simulink. The results showed that FESS is an excellent choice to solve different problems inside MGs such as short-term power interruption and compensating the fluctuations from PV systems. It is shown; adding the FESS to the DC bus of the inverter increased the stability and enabled higher RES penetration levels. Additionally, the system is capable to compensate the reactive power. Finally, we showed the proposed model could, even with high RES penetration levels, has the ability switch smoothly between off-grid inverter in UPS mode and on-grid inverter. As future work, a smart algorithm could be developed to manage the power flow in the optimum cases taking into consideration the load and PV forecasts.

REFERENCES

- [1] M. G. Molina, "Dynamic modelling and control design of advanced energy storage for power system applications," in *Dynamic Modelling*. Rijeka, Croatia: InTechOpen, 2010.
- [2] J. A. P. Lopes, C. L. Moreira, and A. G. Madureira, "Defining control strategies for microgrids islanded operation," *IEEE Trans. Power Syst.*, vol. 21, no. 2, pp. 916–924, May 2006.
- [3] A. A. K. Arania, H. Karamia, G. B. Gharehpetiana, and M. S. A. Hejazi, "Review of flywheel energy storage systems structures and applications in power systems and microgrids," *Renew. Sustain. Energy Rev.*, vol. 69, pp. 9–18, Mar. 2017.
- [4] C. Carrillo, A. Feijóo, and J. Cidrás, "Comparative study of flywheel systems in an isolated wind plant," *Renew. Energy*, vol. 34, no. 3, pp. 890–898, 2009.
- [5] M. Y. Nguyen and Y. T. Yoon, "A comparison of microgrid topologies considering both market operations and reliability," *Electr. Power Compon. Syst.*, vol. 42, no. 6, pp. 585–594, 2014.
- [6] E. Unamuno and J. A. Barrena, "Hybrid ac/dc microgrids—Part I: Review and classification of topologies," *Renew. Sustain. Energy Rev.*, vol. 52, pp. 1251–1259, Dec. 2015.
- [7] A. Awad, I. Tumar, M. Hussein, W. Ghanem, and J. A. Sa'ed, "PV output power smoothing using flywheel storage system," in *Proc. IEEE Int. Conf. Environ. Elect. Eng. IEEE Ind. Commercial Power Syst. Eur. (EEEIC/I&CPS Eur.)*, Jun. 2017, pp. 1–6.
- [8] N. Hamsic, A. Schmelter, A. Mohd, E. Ortjohann, E. Schultze, A. Tuckey, and J. Zimmermann, "Increasing renewable energy penetration in isolated grids using a flywheel energy storage system," in *Proc. Int. Conf. Power Eng., Energy Electr. Drives*, Apr. 2007, pp. 195–200.
- [9] R. Sebastián and R. P. Alzola, "Flywheel energy storage systems: Review and simulation for an isolated wind power system," *Renew. Sustain. Energy Rev.*, vol. 16, no. 9, pp. 6803–6813, 2012.
- [10] L. Zhou and Z. P. Qi, "Modeling and control of a flywheel energy storage system for uninterruptible power supply," in *Proc. Int. Conf. Sustain. Power Gener. Supply*, Apr. 2009, pp. 1–6.
- [11] L. Zhou and Z. Qi, "Modeling and simulation of flywheel energy storage system with IPMSM for voltage sags in distributed power network," in *Proc. Int. Conf. Mechatronics Autom.*, Aug. 2009, pp. 5046–5051.
- [12] H. Toodeji, "A developed flywheel energy storage with built-in rotating supercapacitors," *Turkish J. Electr. Eng. Comput. Sci.*, vol. 27, no. 1, pp. 213–229, 2019.
- [13] L. Barelli, G. Bidini, F. Bonucci, L. Castellini, A. Fratini, F. Gallorini, and A. Zuccari, "Flywheel hybridization to improve battery life in energy storage systems coupled to RES plants," *Energy*, vol. 173, pp. 937–950, Apr. 2019.

- [14] E. Bianconi, J. Calvente, R. Giral, E. Mamarelis, G. Petrone, C. A. Ramos-Paja, G. Spagnuolo, and M. Vitelli, "A fast current-based mppt technique employing sliding mode control," *IEEE Trans. Ind. Electron.*, vol. 60, no. 3, pp. 1168–1178, Mar. 2013.
- [15] L. Shang, J. Hu, X. Yuan, and Y. Huang, "Improved virtual synchronous control for grid-connected VSCs under grid voltage unbalanced conditions," *J. Mod. Power Syst. Clean Energy*, vol. 7, no. 1, pp. 174–185, 2019.
- [16] L. S. Czarnecki, "Instantaneous reactive power p-q theory and power properties of three-phase systems," *IEEE Trans. Power Del.*, vol. 21, no. 1, pp. 362–367, Jan. 2005.
- [17] T.-T. Liu, Y. Tan, G. Wu, and S.-M. Wang, "Simulation of PMSM vector control system based on MATLAB/simulink," in *Proc. Int. Conf. Measuring Technol. Mechatronics Autom.*, vol. 2, Apr. 2009, pp. 343–346.
- [18] P. Pillay and R. Krishnan, "Modeling of permanent magnet motor drives," *IEEE Trans. Ind. Electron.*, vol. 35, no. 4, pp. 537–541, Nov. 1988.
- [19] M. Ghanaatian and S. Lotfifard, "Control of flywheel energy storage systems in the presence of uncertainties," *IEEE Trans. Sustain. Energy*, vol. 10, no. 1, pp. 36–45, Jan. 2019.
- [20] R. G. Lawrence, K. L. Craven, and G. D. Nichols, "Flywheel UPS," *IEEE Ind. Appl. Mag.*, vol. 9, no. 3, pp. 44–50, May 2003.
- [21] U. Damo, M. Ferrari, A. Turan, and A. Massardo, "Solid oxide fuel cell hybrid system: A detailed review of an environmentally clean and efficient source of energy," *Energy*, vol. 168, pp. 235–246, Feb. 2019.



with the Deir-Debwan Industrial School, Ramallah.

AWS SALEH received the B.S. degree in electrical engineering–industrial automation engineering from Palestine Technical University-Kadoorei, Tulkarm, Palestine, in January 2016. He is currently pursuing the M.S. degree in electrical engineering with Birzeit University, Ramallah, Palestine. From January 2016 to February 2017, he was a Research Assistant with the Faculty of Engineering, Palestine Technical University. Since February 2017, he has been a Vocational Trainer



ABDALKARIM AWAD received the bachelor's degree in electrical engineering and the M.Sc. degree in scientific computing from Birzeit University, in 1999 and 2002, respectively, and the Ph.D. degree from the School of Engineering, in 2009. In 2006, he joined the Networking Group, Department of Computer Science, University of Erlangen, Germany supported by the DAAD Scholarship. In 2011, he was a Research Associate with the Integrated Communication Systems

Group, Faculty of Computer Science and Automation, Ilmenau University of Technology. He was an Assistant Professor with the Department of Computer Science 7, University of Erlangen, from 2012 to 2016. He is currently an Assistant Professor with the Department of Electrical and Computer Engineering, Birzeit University. His current research interests include communication-enabled smart grid applications and security and privacy issues in smart grid. His current research interests also include software-defined networking, the Internet of Things, sensor networks, and peer-to-peer systems.



WASEEL GHANEM received the B.Sc. and M.Sc. degrees in electrical engineering–communications and computer systems from the Jordan University of Science and Technology, in 1990 and 1993, respectively, and the Ph.D. degree in electrical and computer engineering–electron devices and sensors from the University Erlangen-Nuremberg and Fraunhofer Institute of Applied Research, Germany, in 1999. In 1994, he received the Scholarship from DAAD for his Ph.D. degree. He served

as the Dean of Engineering and Technology with Birzeit University and has been a Senior Faculty Member with the Electrical and Computer Engineering Department, since 1999. He also served as the Director General for Palestine Education Initiative (PEI) to promote ICT in education within the school system, from 2009 to 2011. His current research interests include robotics, the Internet of Things, machine learning, smart grids, smart sensors, and ICT in education. He participated in many EU Erasmus projects, including RUFO, MVU, and METHODS as a Local Coordinator and a Developer.

• • •