

Parameters Influencing the Performance of an IGBT Gate Drive

Muhammad Abu-Khaizaran*, Patrick Palmer**, and Yalan Wang**

*Birzeit University, Electrical Engineering Department, Birzeit, Palestine

**University of Cambridge, Department of Engineering, Cambridge, UK

Abstract—This paper presents an improvement of an IGBT gate drive implementing Active Voltage Control (AVC), and investigates the impact of various parameters affecting its performance. The effects of the bandwidths of various elements and the gains of AVC are shown in simulation and experimentally. Also, the paper proposes connecting a small Active Snubber between the IGBT collector and its gate integrated within the AVC. The effect of this snubber on enhancing the stability of the gate drive is demonstrated. It will be shown that using a wide bandwidth operational amplifier and integrating the Active Snubber within the gate drive reduces the minimum gate resistor required to achieve stability of the controller. Consequently, the response time of the IGBT to control signals is significantly reduced, the switching losses then can be minimised and, hence, the performance of gate drive as whole is improved. This reflects positively on turn-off and turn-on transitions achieving voltage sharing between the IGBTs connected in series to construct a higher voltage switch, making series IGBTs a feasible practice.

Index Terms—Active Voltage Control, Stability, Bandwidth, Active Snubber, Voltage Sharing, Series Operation.

I. INTRODUCTION

THE Insulated Gate Bipolar Transistor (IGBT) has the attractive features of the simple MOSFET type gate drive requirements and the low on-state voltage drop of the bipolar transistor. Since its invention, the IGBT has become the dominant power electronic switch in medium voltage applications. However, high voltage IGBTs are still slow, rare and expensive. A higher voltage switch, therefore, can be constructed by serially connecting IGBTs, but without sacrificing their attractive features. The differences between individual IGBTs in the same switch may result in unmatched switching transients. Various methods have been proposed to improve voltage sharing and overcome differences between series IGBTs, and these methods vary in their sophistication and accuracy [1]–[6]. Seriesing methods may be classified as load side and gate side; the load side methods mainly rely on snubbers to achieve voltage sharing, whilst the gate side methods rely on the IGBT gate drive to control its switching transitions. Amongst these is the Active Voltage Control (AVC), which can be easily implemented and can reproduce the behavior of most other schemes.

Active Voltage Control (AVC) is a method for series operation of IGBTs, which relies on utilising the IGBT in its active region [7]. The method employs a closed loop around

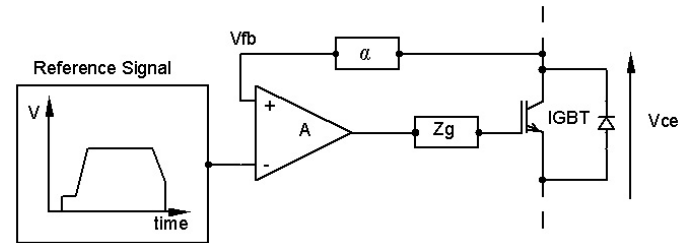

Fig. 1. A schematic of an Active Voltage Controller driving an IGBT

the IGBT, as depicted in Fig. 1, where the collector-emitter voltage (V_{ce}) is intended to follow a predefined reference signal. V_{ce} is fed back to the controller via a potential divider and compared with a reference voltage by means of a wide band current feedback operational amplifier [8]. The reference voltage is produced locally in the gate drive in response to raw on/off digital pulses. This controller accounts for the different switching characteristics and different gate delay times that may appear between the series IGBTs in a string.

The turn-off delays and the discrepancies between the series IGBTs may arise due to unmatched IGBTs during manufacturing, temperature dependencies and circuit layouts. To overcome these differences, the reference voltage has a two-step turn-off edge; a step and a ramp. During the step, the gate drive overcomes the non-linearities associated with the IGBT's Miller capacitance and the gate delays [9]. At the end of this step, all the IGBTs are ready to switch off with a predefined $\frac{dv}{dt}$; the ramp. The switching losses can be minimised by designing the controller with a steep ramp. Fortunately, the AVC method has the capability of clamping and limiting the voltage overshoot, which guarantees that the Safe Operating Area (SOA) of any of the respective IGBTs is not exceeded. On the other hand, at turn-on transition, the AVC reference voltage is designed to have two segments. The first segment has a small slope to allow the feedback voltage (the scaled collector-emitter voltage) to catch up with the reference voltage and to allow a gentle diode reverse recovery, whilst the second is very steep to reduce the switching losses [10].

The AVC method will be investigated as a gate control scheme for the IGBT implemented in a chopper circuit. A

modified AVC with improved performance will be demonstrated. Further implications of this method and thorough investigation of the switching behavior will be addressed in detail in this paper by simulation and experimentally. The feasibility of applying AVC method to IGBT gate drives to achieve voltage sharing between three series IGBTs will be demonstrated experimentally.

II. SIMULATION OF THE ACTIVE VOLTAGE CONTROLLER

Various parameters are involved in the design of the Active Voltage Controller (AVC), which are found to affect the performance of the AVC. A real AVC has finite feedback and operational amplifier (op-amp) bandwidths, and there are stray inductances in the gate and output loops. Along with the gate resistor, these play an influential role in the performance of the gate drive. A chopper circuit, shown in Fig. 2, was simulated in time domain in order to investigate the effects of these various parameters on the performance of the AVC. In addition, the impact of connecting a small Active Snubber between the IGBT collector and its gate, within the AVC, is explored. The criterion for the sensitivity of the AVC to parametric change, considered here, is the response of switching devices in terms of the current and the voltage waveforms; the IGBT current (I_C), the diode current (I_D), and the AVC control signals (the feedback voltage (V_{fb}), and the IGBT gate-emitter voltage (V_{ge}) and the reference voltage (V_{ref})).

The default parameters used in the simulation are labelled in Fig. 2. These parameters are very close to the values found in the AVC and the chopper circuit used for experimental work. The default feedback bandwidth (f_{fb}) is 32MHz and the default operational amplifier bandwidth (f_{op}) is 90MHz. The operational amplifier gain (A_{op}) was set to 7 and the feedback gain (α) was set to 0.023. The converter stray inductances are as shown in Fig. 2; the gate inductance $L_g = 10\text{nH}$, the emitter inductance $L_e = 5\text{nH}$, the collector inductance $L_c = 100\text{nH}$, and the stray inductance in the output loop $L_s = 1\mu\text{H}$. The default gate resistor $R_g = 8\Omega$. Initially, the Active Snubber was disconnected.

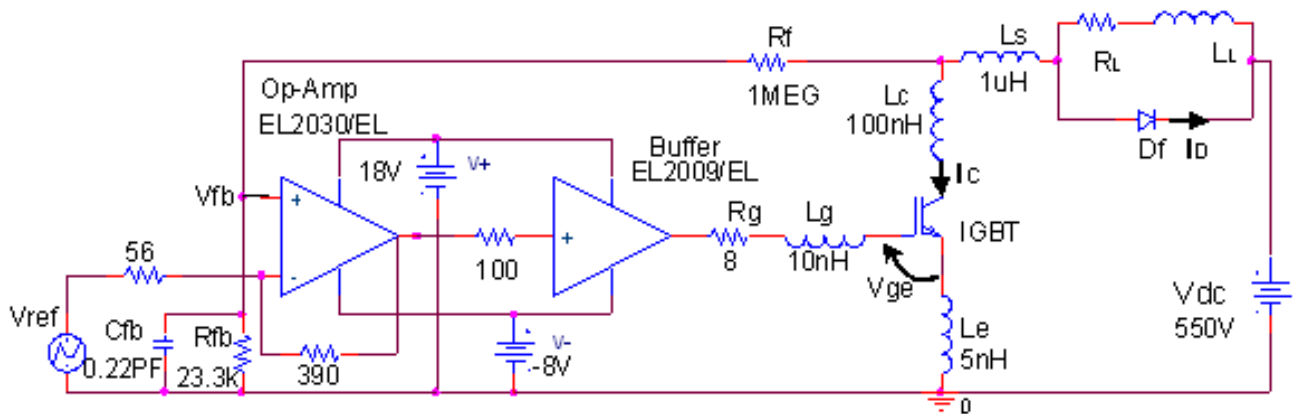

Fig. 2. The simulation circuit of an Active Voltage Controller driving an IGBT implemented in a chopper circuit

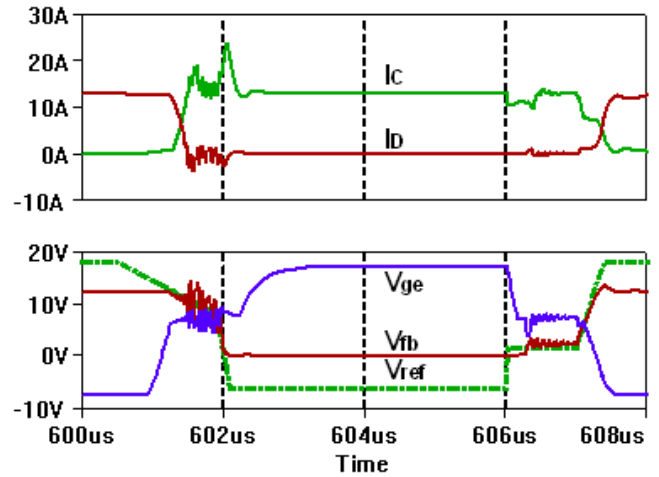

Fig. 3. The switching waveforms at the default parameters; $R_g = 8\Omega$

A. The Gate Resistor

The switching waveforms at turn-on and turn-off for the default values are shown in Fig. 3. Clearly, there are oscillations at the turn-on and turn-off transitions due to insufficient damping. As expected, the gate resistor (R_g) is necessary to dampen the system response at both turn-on and turn-off. Fig. 4 shows that increasing R_g to 12Ω removed the unwanted ringing from the waveforms. Thus, the AVC is operative and the bandwidth of the IGBT with 12Ω of R_g is not limiting the performance. At the turn-on transition, the two-stage diode reverse recovery is apparent, with a significant current drawn during the rapid $\frac{dv}{dt}$ stage.

B. Active Voltage Controller Bandwidths

Figs. 5 and 6 show that the AVC was stabilised at the default parameters without increasing the gate resistor, but with increasing the bandwidths of individual elements in the AVC. Fig. 5 demonstrates that increasing the feedback bandwidth (f_{fb}) to 100MHz was sufficient to stabilise the controller. On the other hand, increasing the operational amplifier bandwidth (f_{op}) to 180MHz by using a wider bandwidth operational amplifier (EL2160) improved the stability of the AVC, as

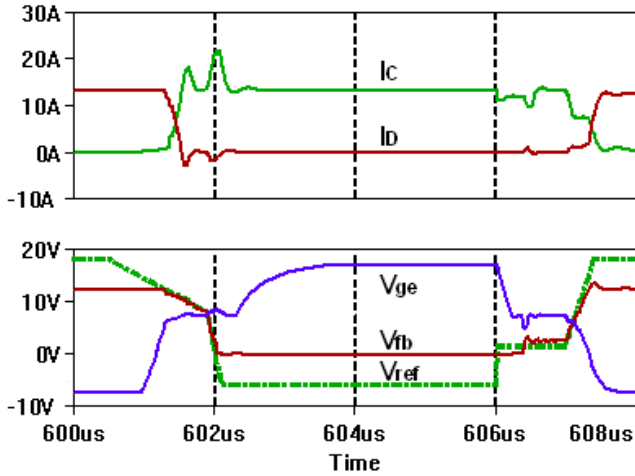

Fig. 4. The switching waveforms as a result of increasing the gate resistor (R_g) to 12Ω ; other parameters are at their default values.

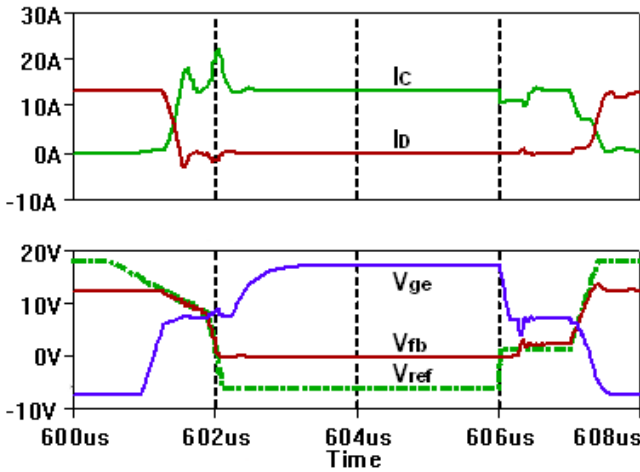

Fig. 5. The switching waveforms as a result of increasing the feedback bandwidth (f_{fb}) to 100MHz ; other parameters are at their default values.

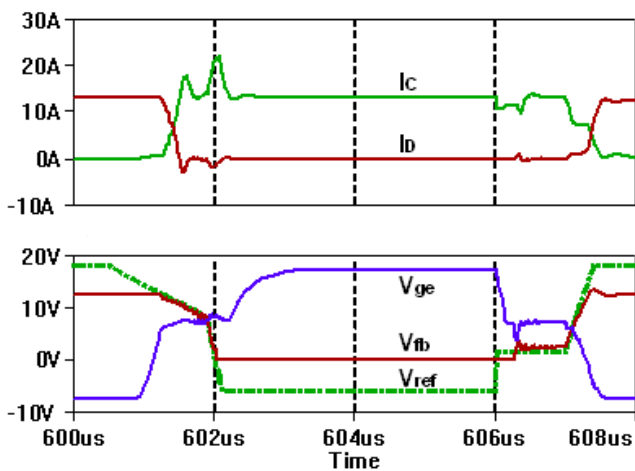

Fig. 6. The switching waveforms as a result of increasing the operational amplifier bandwidth (f_{op}) to 180MHz ; other parameters are at their default values.

shown in Fig. 6. The stability is improved although the figures look very similar. These figures stress the need for high bandwidths to achieve a well damped response with a low value of R_g , thus reducing the response time and improving the overall performance of the gate drive.

C. Active Voltage Controller Gains

Figs. 7 and 8 show the time domain response of the AVC under the change of either the operational amplifier gain (A_{op}) or the feedback gain (α). When the operational amplifier gain (A_{op}) was increased from 7 to 10, a gate resistor of at least 18Ω was needed to stabilise the controller, as seen in Fig. 7. In comparison, when the feedback gain (α) was increased from 0.023 to 0.04, a gate resistor of at least 15Ω was needed to stabilise the controller, as shown in Fig. 8. Increasing either gain causes the system response to become more oscillatory, but reduces the error between the feedback voltage (V_{fb}) and the reference voltage (V_{ref}).

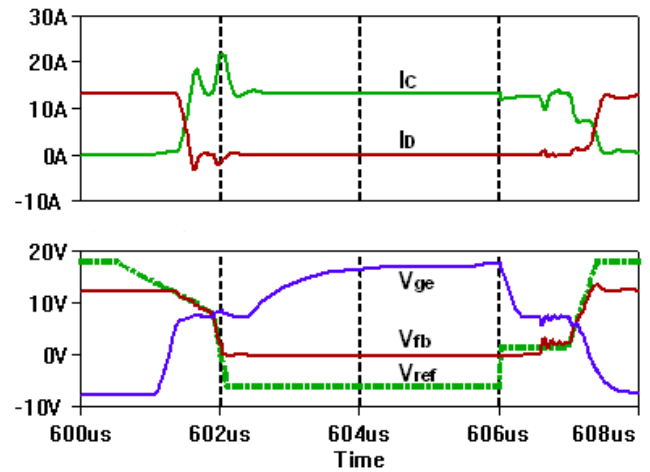

Fig. 7. The switching waveforms with increasing the operational amplifier gain (A_{op}) to 10 and the gate resistor (R_g) to 18Ω ; other parameters are at their default values.

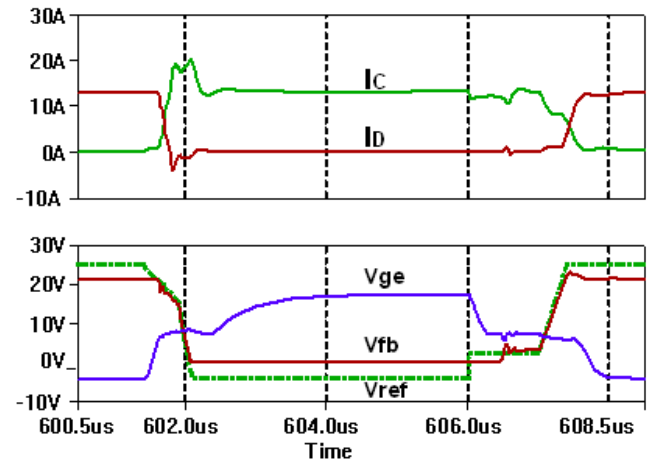

Fig. 8. The switching waveforms with increasing the feedback gain (α) to 0.04 and the gate resistor (R_g) to 15Ω ; other parameters are at their default values.

These results are consistent with classic control theory; increasing the gain drives the system towards the right hand plain and reduces the damping of the system. Nonetheless, A_{op} should be high enough to saturate the IGBT gate during the on-state. However, α and A_{op} should be kept as low as possible to minimise the oscillations. Also, Fig. 8 demonstrates the attractive clamping feature of the AVC, where the overshoot in the feedback voltage (V_{fb}) starts to flatten, at the turn-off transition, and the fall in the collector current (I_c) slows down and extends for a longer period as the voltage overshoot approaches the maximum value of the reference voltage.

D. Active Snubber

When an Active Snubber of 33pF and 10Ω was connected between the IGBT collector and its gate, the AVC became stable at the default parameters without increasing the gate resistor, as shown in Fig. 9. The addition of the small Active Snubber does not slow the switching waveforms as seen from the figure, but it significantly increases the damping of the drive.

E. Improved Gate Drive Design

Including an Active Snubber (33pF and 10Ω) and EL2160, whose bandwidth is 180MHz, in the AVC significantly improves its performance. It was found that the stability of the AVC is enhanced even at a lower value of the gate resistor (R_g), as shown in Fig. 10; only an R_g of 6Ω was sufficient to stabilise the AVC. Hence, including an Active Snubber in the AVC and increasing its components' bandwidths significantly reduce the value of the gate resistor needed to stabilise the controller, therefore, improve the IGBT's response to the reference voltage.

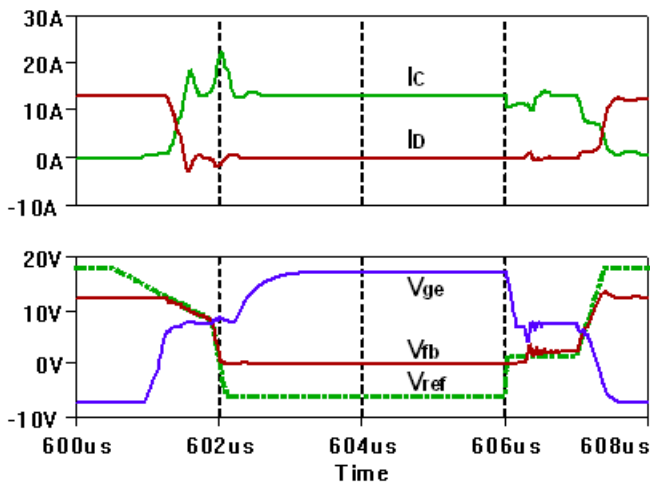

Fig. 9. The Active Voltage Control was stabilised at the default parameters when an Active Snubber (33pF and 10Ω) was included.

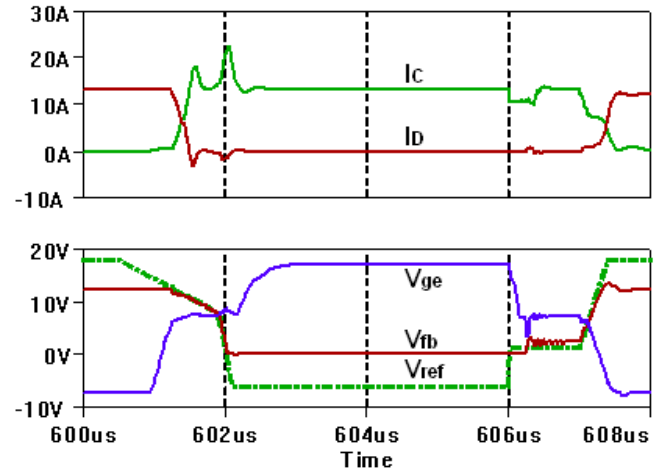

Fig. 10. Incorporating an Active Snubber (33pF and 10Ω) and a wider bandwidth operational amplifier ($f_{op} = 180\text{MHz}$) with the Active Voltage Controller reduces the gate resistor ($R_g = 6\Omega$) needed to stabilise it; other parameters are at their default values.

III. EXPERIMENTAL RESULTS

A boost converter was set up to demonstrate the effects of various parameters on the performance of the Active Voltage Control gate drive, and to validate the improvement of the design demonstrated in simulation. The gate drive was initially operated with an operational amplifier whose bandwidth (f_{op}) is 90MHz (EL2030), a feedback bandwidth (f_{fb}) of 32MHz, an operational amplifier gain (A_{op}) of 7, a feedback gain (α) of 0.005, and a gate resistor (R_g) of 15Ω. The Active Snubber was initially disconnected. In the experimental results, the current scale is at 5A/division and the voltage scale is at 100V/division, unless otherwise stated.

A. The Gate Resistor

Fig. 11 shows the turn-off waveforms at the aforementioned default parameters of the practical AVC gate drive. The gate drive is unstable as seen in the IGBT collector-emitter voltage (V_{ce}) and collector current (I_c). Increasing the gate resistor (R_g) from 15Ω to 24Ω increases the damping and stabilises the gate drive, as shown in Fig. 12.

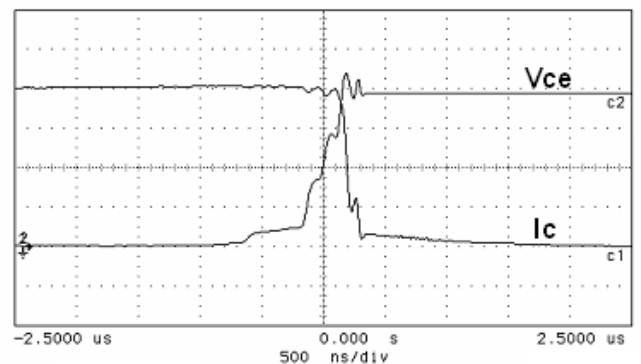

Fig. 11. The turn-off waveforms of the IGBT are unstable at the default parameters of the Active Voltage Control gate drive.

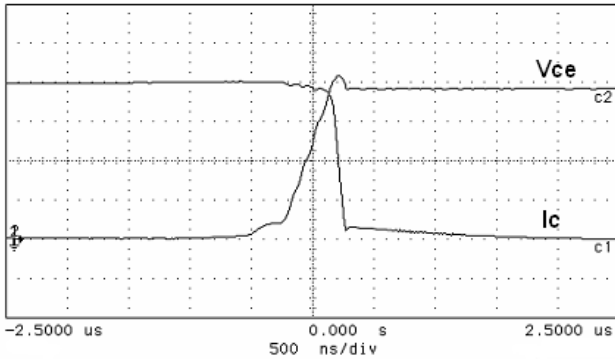

Fig. 12. The turn-off waveforms of the IGBT when the gate resistor (R_g) of the Active Voltage Control gate drive was increased to 24Ω ; other parameters are at their default values.

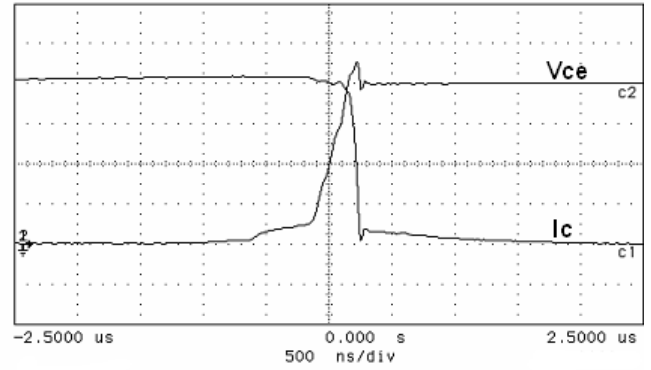

Fig. 14. The turn-off waveforms of the IGBT are stabilised with a gate resistor (R_g) of 33Ω when the operational amplifier gain (A_{op}) was increased to 10; other parameters of the AVC are at their default values.

B. Operational Amplifier Bandwidth

Increasing the operational amplifier bandwidth (f_{op}) from 90MHz to 180MHz, by using a wider bandwidth operational amplifier (EL2160 instead of EL2030), stabilises the AVC gate drive despite using the default values of the AVC parameters, as shown in Fig. 13. The switching waveforms in this figure verify the simulation results which were shown in Fig. 6.

C. Operational Amplifier Gain

When the operational amplifier gain (A_{op}) was increased from 7 to 10, whilst the other parameters of the AVC were set to their default values, a gate resistor of 24Ω was insufficient to stabilise the controller. The gate resistor has to be increased to 33Ω to stabilise the AVC, as shown in Fig. 14. The switching waveforms in this figure validate the simulation results shown in Fig. 7.

D. Active Snubber

Fig. 15 shows that connecting an Active Snubber of 33pF and 10Ω between the collector of the IGBT and its gate stabilises the controller at the default parameters without

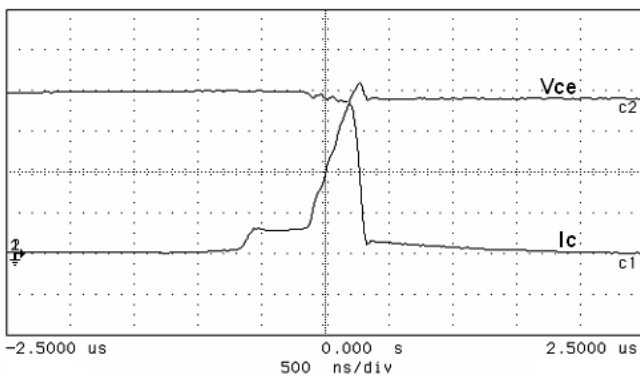

Fig. 13. The turn-off waveforms of the IGBT are well damped when the operational amplifier bandwidth (f_{op}) was increased to 180MHz; other parameters of the AVC are at their default values.

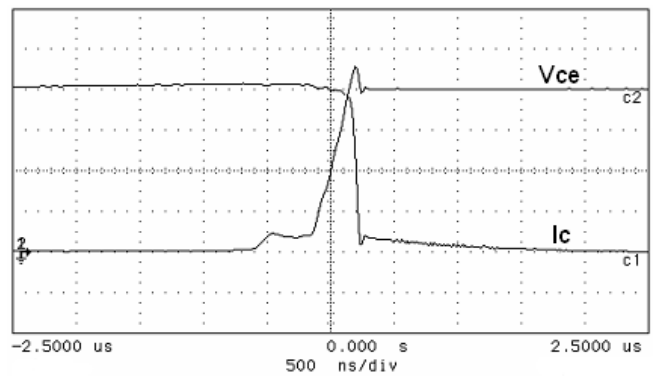

Fig. 15. The turn-off waveforms of the IGBT are well damped when an Active Snubber of 33pF and 10Ω was included in the AVC; other parameters are at their default values.

increasing R_g or increasing the AVC bandwidths. Similar results were obtained by simulation and were shown in Fig. 9.

E. Active Snubber and Wider Op-Amp Bandwidth

When the operational amplifier bandwidth was increased to 180MHz and an Active Snubber of 50pF and 10Ω was employed, it was possible to stabilise the Active Voltage Controller with a smaller value of gate resistor than its default value; the other parameters were set to their default values. Fig. 16 shows the switching waveforms of the IGBT under the aforementioned conditions, but with using a gate resistor (R_g) of 10Ω instead of 15Ω . The waveforms are well damped and the oscillation are vanished. The figure implies that the performance of the AVC can be significantly improved and the stability can be enhanced, even at a smaller value of gate resistor, by integrating an Active Snubber within the AVC and by using a wider bandwidth operational amplifier. This is consistent with the simulation results shown in Fig. 10. Smaller values of gate resistor are desirable to reduce the response time of the IGBT to control signals at both turn-on and turn-off transitions.

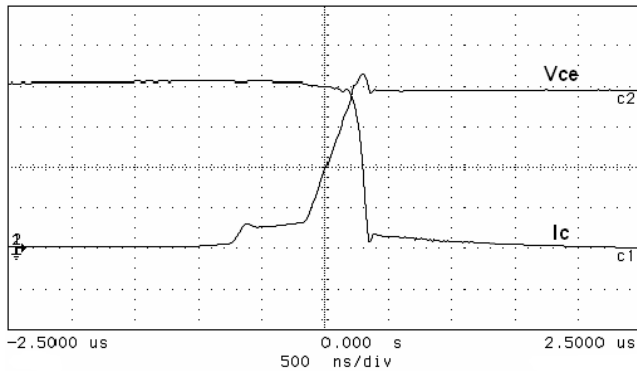

Fig. 16. The turn-off waveforms of the IGBT are stabilised with a gate resistor (R_g) of only 10Ω when the operational amplifier bandwidth (f_{op}) was increased to 180MHz and an Active Snubber was included in the AVC; other parameters are at their default values.

F. Series IGBTs

Three IGBTs were connected in series to demonstrate the ability of the Active Voltage Control gate drive to achieve the voltage sharing between devices in a string. The traces in the top plot of Fig.17 show the turn-off collector-emitter voltages of the three series IGBTs (V_{ce1} , V_{ce2} and V_{ce3}), whilst the traces in the bottom plot show the total switch voltage (V_{sw}) and the switch current (I_{sw}). Despite using identical gate drives and identical IGBTs, there is a mismatch in the response (delay) time of the three series IGBTs. This mismatch is apparent from the time lag between the three collector-emitter voltages during the step of the off transition. Nonetheless, all the IGBTs are sharing well the voltage during the ramp. The voltage scale is 200V/div for individual IGBTs collector-emitter voltages, 300V/div for the total switch voltage, 50A/div for the switch current, and 200ns/div for time base.

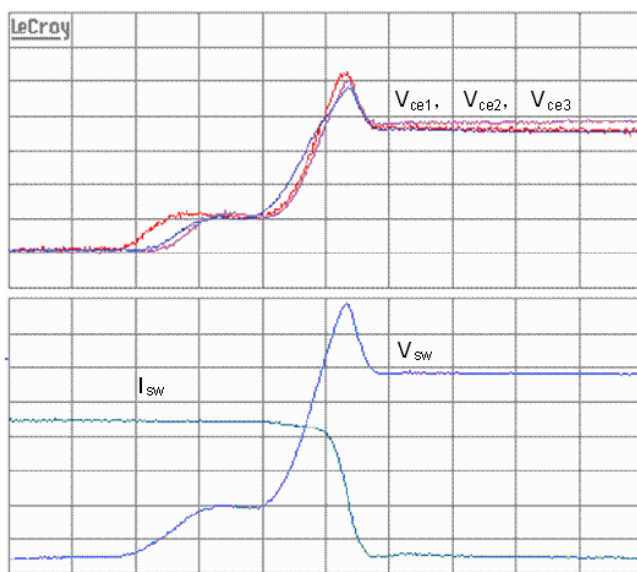

Fig. 17. The switching waveforms of three IGBTs connected in series to construct a higher voltage switch

IV. SUMMARY AND CONCLUSIONS

The experimental and simulation results are consistent with each other. The main conclusions that can be drawn from the results presented in this paper are:

- A small value of R_g is needed to reduce the response time of the system and to achieve controllability, especially at turn-on, but it should be large enough to stabilise the AVC, forming the main compensating pole with the IGBT input capacitance.
- The performance of the AVC is significantly improved when the bandwidths of the feedback potential divider and the operational amplifier are increased.
- Small values of AVC gains are desirable for achieving a stable AVC, but they should be large enough to saturate the IGBT during conduction and to reduce the steady state error.
- At turn-on, a two-slope reference voltage (V_{ref}) improves the performance of the AVC, allowing a two-stage diode reverse recovery process.
- Connecting a small Active Snubber between the IGBT collector and its gate significantly improves the stability of the AVC.
- An improved performance of the Active Voltage Controller can be achieved by incorporating a small Active Snubber and wide bandwidth components with the gate drive.
- The Active Voltage Control simplifies seriesing IGBTs making a higher voltage switch a feasible practice.

REFERENCES

- [1] S. Hong, V. Chitta, and D.A. Torrey. "Series Connection of IGBTs with Active Voltage Balancing". *IEEE Transactions on Industry Applications*, 35(4):917–923, July/August 1999.
- [2] G. Belverde, A. Galluzzo, M. Melito, S. Musumeci, and A. Raciti. "Snubberless Voltage Sharing of Series-Connected Insulated-Gate Devices by a Novel Gate Control Strategy". *IEEE Transactions on Power Electronics*, 16(1):132–141, January 2001.
- [3] D. Zhou and D.H. Braun. "A Practical Series Connection Technique for Multiple IGBT Devices". In *Proc. IEEE Power Electronics Specialist Conf., 2001*, volume 4, pages 2151–2155.
- [4] K. Sasagawa, Y. Abe, and K. Matsuse. "Voltage Balancing Method for IGBTs Connected in Series". In *Proc. IEEE Industry Applications Society Conf., 2002*, volume 4, pages 2597–2602.
- [5] Y. Wang, A.T. Bryant, P.R. Palmer, S.J. Finney, M. Abu-Khaizaran, and G. Li. "An Analysis of High Power IGBT Switching under Cascade Active Voltage Control". In *Proc. IEEE Industry Applications Society Conf., 2005*, volume 2, pages 806–812.
- [6] A.N. Githiari, R.J. Leedham, and P.R. Palmer. "High Performance Gate Drives for Utilizing the IGBT in the Active Region". In *Proc. IEEE Power Electronics Specialist Conf., 1996*, volume 2, pages 1754–1759.
- [7] P.R. Palmer and A.N. Githiari. "The Series Connection of IGBTs with Active Voltage Sharing". *IEEE Transactions on Power Electronics*, 12(4):637–644, July 1997.
- [8] P.R. Palmer, H.S. Rajamani, and N. Dutton. "Experimental Comparison of Methods of Employing IGBTs Connected in Series". *IEE Proceedings Electrical Power Applications*, 151(5):576–582, September 2004.
- [9] P.R. Palmer, A.N. Githiari, and R.J. Leedham. "Some Scaling Issues in the Active Voltage Control of IGBT Modules for High Power Applications". In *Proc. IEEE Power Electronics Specialist Conf., 1997*, volume 2, pages 854–860.
- [10] M.S. Abu-Khaizaran. "The Design of a High Power IGBT Based Current Source Inverter Drive". PhD thesis, University of Cambridge, Cambridge, UK, January 2003.